

RECESSED SPOT

S-SPT-D30



Classical and powerful projector light. High efficiency product with inner 45° tilt and 350° rotation angles. Available in several colors and beam angles.

Projecteur classique et puissante. Produit à haute efficacité avec une inclinaison intérieure de 45° et des angles de rotation de 350°. Disponible en plusieurs couleurs et angles de faisceau.

AC Input	220 – 240 V	<i>Alimentation</i>
Light Source	COB	<i>Source</i>
Wattage	50W	<i>Puissance</i>
Lumen Output	5349Lm	<i>Flux lumineux</i>
Efficiency	107Lm/W	<i>Efficacité</i>
Beam Angle	18° 32° 65°	<i>Angles</i>
Color (K)	3000°K 4000°K	<i>Température de couleur</i>
Finish	Black White	<i>Finition</i>
Working Temperature	-20° / +40°C	<i>Température de fonctionnement</i>
Lifetime	50,000h	<i>Durée de vie</i>
Standard	L80B10	<i>Norme</i>

Protection	IP20	<i>Indice</i>
Dimming (Option)	DALI 1-10V Phase Dimming	<i>Contrôle (Option)</i>
Certification	CE RoHS	<i>Certification</i>
CRI	80 90	<i>IRC</i>
Safety Class	□	<i>Classe de sécurité</i>
EN62471	RG0	<i>EN62471</i>
SDCM	≤3	<i>SDCM</i>
UGR	≤19	<i>UGR</i>

Dimensions | *Dimensions*

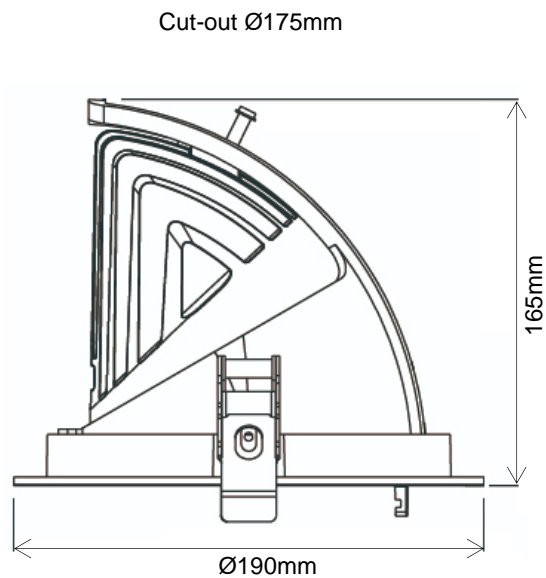

Product Code Generator | *Générateur de code produit*

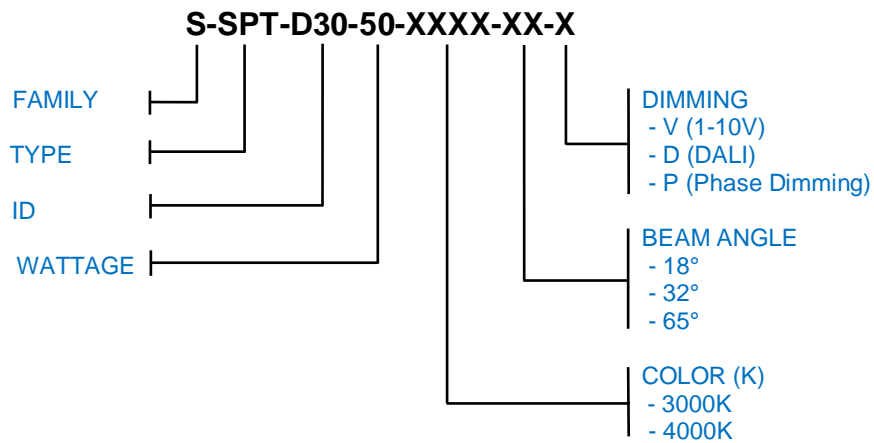

LUMEN

AT WORK



contact@lumen-at-work.com | www.lumen-at-work.com

© LUMEN AT WORK. All rights reserved. The information provided herein is subject to change, without notice.