

RECESSED DOWNLIGHT

S-DWN-IMSB120



15W & 20W recessed downlight with recessed low glare frame. Fitted with quarter-turn interchangeable LED module. Available in several colors and beam angles.

Spot encastré disponible en 15W et 20W, basse luminance. Equipé d'un module LED interchangeable quart de tour. Disponible en plusieurs couleurs et faisceaux.

AC Input	100 – 240 V	<i>Alimentation</i>
Light Source	COB	<i>Source</i>
Wattage	15W 20W	<i>Puissance</i>
Lumen Output	1710Lm 2192Lm	<i>Flux lumineux</i>
Efficiency	110Lm/W	<i>Efficacité</i>
Beam Angle	15° 28° 36°	<i>Angles</i>
Color (K)	2700°K 3000°K 4000°K 5000°K	<i>Température de couleur</i>
Finish	Black White	<i>Finition</i>
Working Temperature	-20° / +40°C	<i>Température de fonctionnement</i>
Lifetime	50,000h	<i>Durée de vie</i>
Standard	L80B10	<i>Norme</i>
Protection	IP20	<i>Indice</i>

Dimming (Option)	DALI 1-10V Phase Dimming	<i>Contrôle (Option)</i>
Certification	CE RoHS	<i>Certification</i>
CRI	80 90	<i>IRC</i>
Safety Class	□	<i>Classe de sécurité</i>
EN62471	RG0	<i>EN62471</i>
SDCM	≤3	<i>SDCM</i>
UGR	≤19	<i>UGR</i>

Dimensions | *Dimensions*

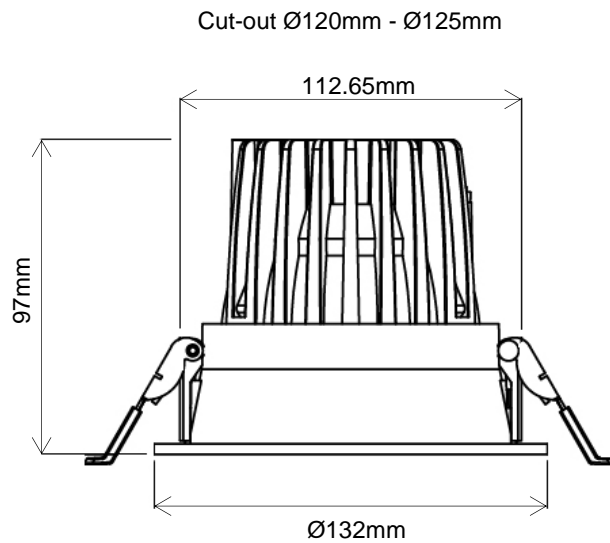

Product Code Generator / *Générateur de code produit*

